

VITA



ECOPERLA



WATER
SOFTENER

**ECOPERLA
VITA**

original product of Ecoperla

USER MANUAL

KEEP THIS USER MANUAL, SINCE IT CONTAINS THE WARRANTY AND THE SERVICE CARD

TABLE OF CONTENTS

1. Introduction	5
1.1. Safety measures	5
1.2. Water softening	5
1.3. Description of device operation	6
1.4. Operation and maintenance	6
2. Technical data	7
3. System components	8
4. Installation and commissioning	8
4.1. Requirements	8
4.2. Installation diagram	9
4.3. Control valve	10
4.4. Installation	11
5. Programming	12
5.1. Operating mode displays	12
5.2. Language	12
5.3. Initial settings	13
5.3.1. Initial hardness	13
5.3.2. Final hardness	13
5.3.3. Days between regenerations	14
5.3.4. Regeneration time settings	14
5.3.5. Current time setting	14
5.4. Individual operation mode setting	15
5.4.1. Selection of operation mode	15
5.4.2. Brine-up time	15
5.4.3. Backwash time	15
5.4.4. Rinse time	16
5.4.5. Fill time	16
5.4.6. Ion exchange capacity	16
5.4.7. Regeneration frequency	17
5.4.8. Regeneration time selection	17
5.4.9. Relay 1 settings	18
5.4.10. Relay 2 settings	18
5.4.11. Remaining salt alert	18
5.5. Operating history	19
5.5.1. Number of days since regeneration	19
5.5.2. Number of m³ since regeneration	19
5.5.3. Reserve volume	20
5.5.4. Regeneration history	20
5.5.5. Maximum instantaneous flow	20
5.6. Extended history	20
5.6.1. Software version	20
5.6.2. Total number of days	21
5.6.3. Total number of regenerations	21
5.6.4. Total volume	21
5.6.5. Error history	21

6. Operation	22
6.1. Water softener operation	22
6.2. General information	22
6.3. List of requirements for proper operation	22
6.4. User maintenance	22
6.5. Medium cleaning	23
6.6. Medium disinfection	23
6.7. Consumables	23
6.8. Loss of warranty	23
7. Service	24
7.1. Activities carried out by the service technician	24
7.2. Groundless request of warranty service	24
8. Troubleshooting	25
9. Service card	29
10. Warranty	30

1. INTRODUCTION

1.1. SAFETY MEASURES

- Read this user manual before installing the device and follow the instructions carefully during installation and operation. The manual contains all necessary information on safety precautions during installation, operation and service of the device.
- Correct installation and operation of the device in accordance with the user manual will ensure trouble-free, effective and long-lasting operating life.
- The device reduces water hardness and improves organoleptic properties of water. It may only be used for this purpose.
- You can install the device yourself.
- The device should be transported vertically. Do not lay it on the side, as it may cause the risk of damage.
- Keep this user manual.
- The device was manufactured in accordance with the latest applicable safety requirements.

1.2. WATER SOFTENING

According to the current Regulation of the Minister of Health on the Quality of Water Intended for Human Consumption, general hardness of water in Poland should be between 60 and 500 mg CaCO₃/dm³ of water. Water with hardness not exceeding 75 mg CaCO₃/dm³ is considered to be very soft water. Hard and very hard water has total hardness from 300 to over 500 mg CaCO₃/dm³.

There are two types of water hardness, which form so-called general hardness. The first type is carbonate hardness. It is caused by calcium and magnesium carbonates and bicarbonates. These compounds form a deposit after precipitation from water. This type of hardness can be removed by thermal water treatment. Carbonate hardness is also known as transient hardness. The second type is non-carbonate hardness, also referred to as non-transient hardness. It is responsible for presence of substances such as chlorides, nitrates, sulphates, soluble salts, including calcium and magnesium salts.

High hardness of tap water has a significant impact on the life and environment of those who use it. Hardness of water has a great impact on its surface tension. The higher the surface tension, the more difficult it is to moisten various surfaces. As a result, cleaning bathroom and kitchen fittings becomes more difficult. You need to use greater amount of detergents and cosmetics, such as soap, hair shampoo, etc. This in turn results in higher expenses and has a negative impact on the environment.

In addition, sediment precipitated during thermal processing of water may cause faster wear and tear of household appliances which come into contact with water. These include washing machines, dishwashers, irons and kettles. The use of hard water may cause laundry to lose its original colour and become rough. Drinks and food prepared with hard water may lose their qualities.

Hard water may have a direct, negative impact on the human body. Those who are susceptible to kidney stones should be particularly careful about using hard water. Additionally, hard water negatively affects skin and hair condition. This is particularly true for people with hypersensitive skin.

Water with hardness exceeding 200 mg CaCO₃/dm³ causes scaling in the water supply and heating systems. This results in significant energy losses. Hard water can also have an adverse effect on domestic plants. They may look bad and eventually die.

1.3. DESCRIPTION OF DEVICE OPERATION

The Ecoperla Vita water softener uses an ion exchange resin to remove calcium (Ca²⁺) and magnesium (Mg²⁺) ions, which cause water hardness. The device removes hardness from water totally or partially.

Calcium ions Ca²⁺ and magnesium ions Mg²⁺ are removed when water flows through the ion exchange resin in the water softener tank. In the ion exchange resin there are many so-called active centres, which attract positive calcium and magnesium ions (cations). The attracted cations are replaced by sodium cations, which do not cause hardness.

Once the active centres have been replaced by calcium and magnesium ions, the ion exchange resin must undergo regeneration. This consists in removing Ca²⁺ and Mg²⁺ by backwashing the resin with brine solution coming a separate tank. After regeneration, the medium regains its full water softening efficiency. All water used during regeneration is directed to the sewage system.

1.4. OPERATION AND MAINTENANCE

Proper operation of the device requires regular refilling of the salt container with salt tablets. The regeneration frequency and the quantity of refilled salt depends on water hardness and the size of water intake. Average salt consumption is 25 kg salt bag per month. The cartridge in the pre-filter must be replaced regularly to prevent noticeable pressure drops that could interfere with proper operation of the device.

BEWARE: We recommend using the Ecoperla Antidotum resin cleaning granules and Ecoperla Antibacter, water disinfection and maintenance product interchangeably every 6 months.

Table: conversion of water hardness units

	mmol/l	mval/L	mg CaCO ₃ (ppm)	German degree °d	French degree °f	English degree °e
mmol/l	1	2	100	5,6	10	7
mval/l	0,5	1	50	2,8	5	3,5
mg CaCO ₃ (ppm)	0,01	0,02	1	0,056	0,1	0,07
German degree °d	0,179	0,357	17,9	1	1,79	1,25
French degree °f	0,1	0,2	10	0,56	1	0,70
English degree °e	0,143	0,29	14,3	0,8	1,43	1

2. TECHNICAL SPECIFICATIONS

	Ecoperla Vita 12	Ecoperla Vita 25
Control valve	CLACK CI UF	CLACK CI UF
Connection	1" GZ	1" GZ
Medium amount [L]	12	25
Medium	Monosphere ion exchange resin	Monosphere ion exchange resin
Recommended flow rate [m3/h]	1,0 m3/h	1,5 m3/h
Maximum flow rate [m3/h]	2,0 m3/h	3,0 m3/h
Operating pressure [bar]	2,0 - 6,0	2,0 - 6,0
Salt consumption per regeneration [kg]	1,5	3,0
Water consumption per rinsing [L]	85	130
Width [mm]	320	320
Height [mm]	650	1120
Depth [mm]	500	500
Connection height [mm]	495	960
Connection width [mm]	80	80
Power supply	230 V/50 Hz	230 V/50 Hz
Water amount between regenerations in the case of 10 dH hardness	2,4	5,1



3. SYSTEM COMPONENTS

Ecoperla Vita consists of several components:

- Cabinet with brine tank, float and brine hose,
- Pressure cylinder,
- Control valve,
- Ion exchange resin,
- Water softener connections,
- Power supply unit,
- User manual.

4. INSTALLATION AND COMMISSIONING

4.1. REQUIREMENTS

For proper operation, the water softener requires appropriate working conditions:

- The working pressure should be within the range of 2.0÷6.0 bar.
- The pressure in the device should not exceed the maximum working pressure or drop below atmospheric pressure of 0 bar (vacuum), as it may cause damage.
- The working temperature should be between 4 and 38°C.
- The device should be protected against weather conditions (sunshine, precipitation, too low or too high temperatures).
- High humidity in the room can cause condensation on the device and piping, and in extreme cases it can damage the electronic board.
- A pre-filter must be installed before the water softener.
- The device should be placed vertically and on a hard flat surface.
- The device should also be transported vertically.
- The control valve needs to be connected to 230 V, 50 Hz electrical supply according to the national standards.
- The quality of the feed water, particularly with regard to iron and manganese content, turbidity, pH, chlorides and microorganisms should be in accordance with drinking water standards. The use of water with significant exceedances of e.g. iron may result in irreversible damage to the medium.

4.2. INSTALLATION DIAGRAM

ECOPERLA VITA CONNECTION DIAGRAM

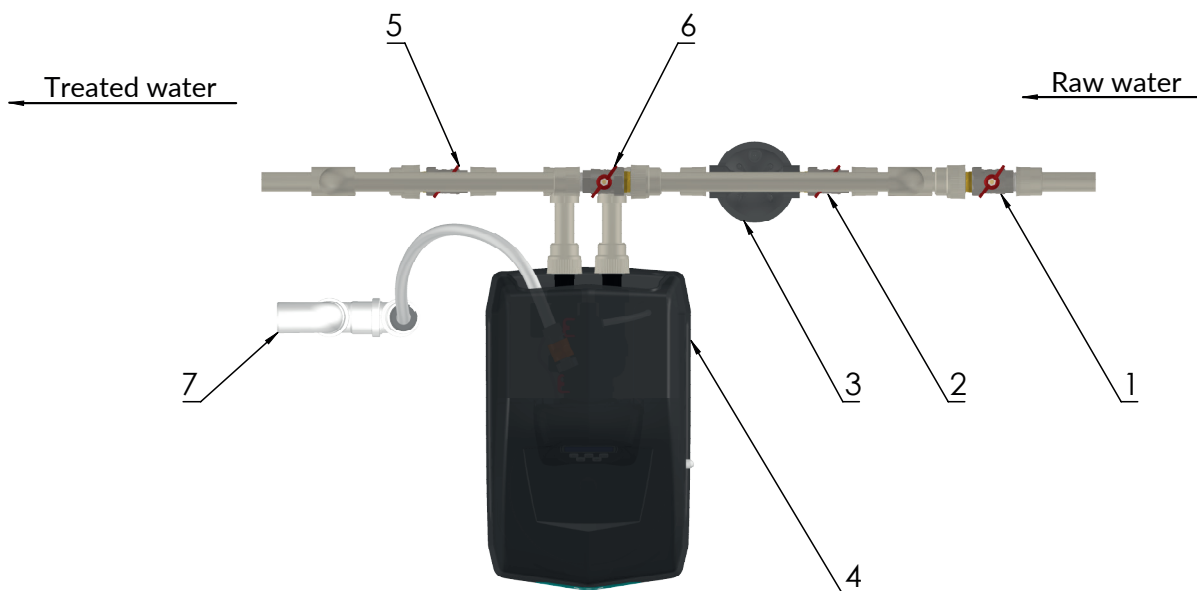
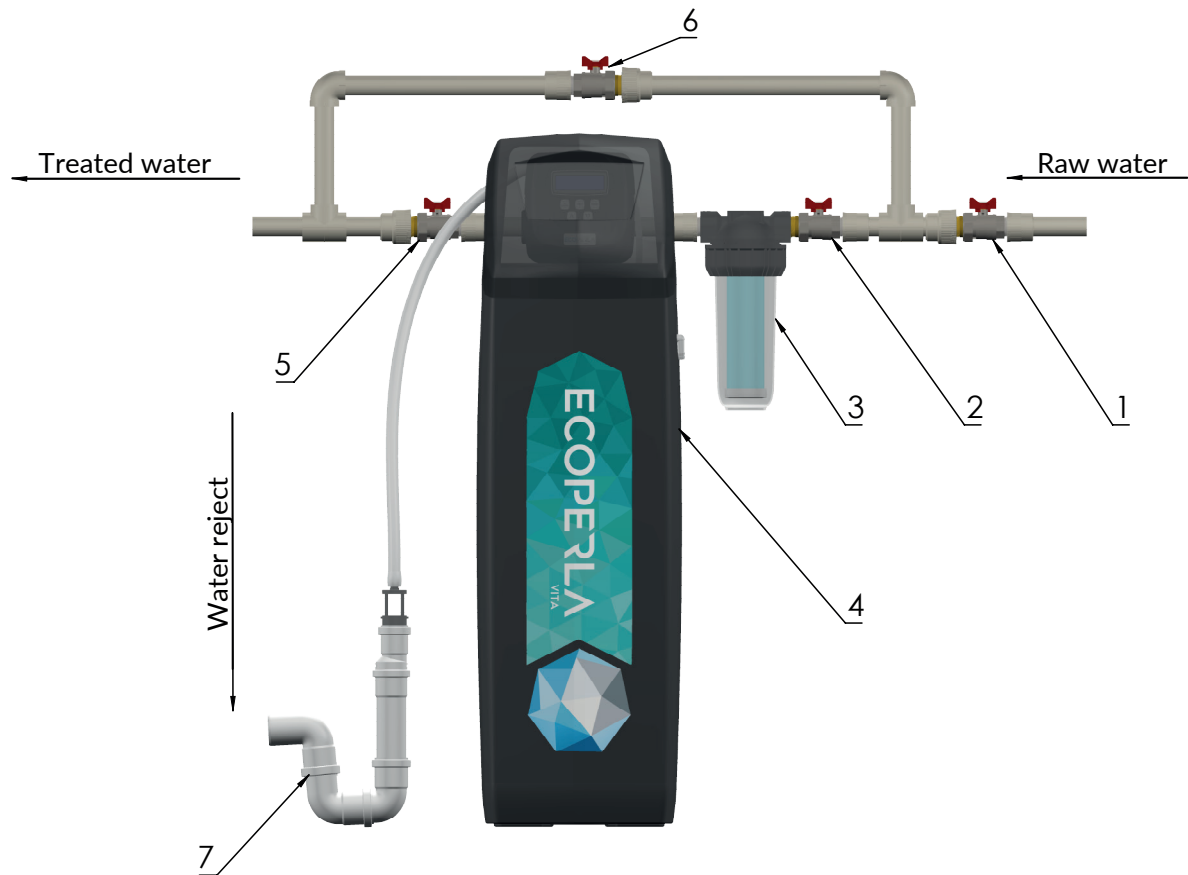

1.	Main water shut-off valve
2.	Inlet valve to Ecoperla Vita
3.	Mechanical water filter
4.	Ecoperla Vita
5.	Outlet valve from Ecoperla Vita
6.	Bypass valve
7.	Drain to the sewage system

4.3. CONTROL VALVE

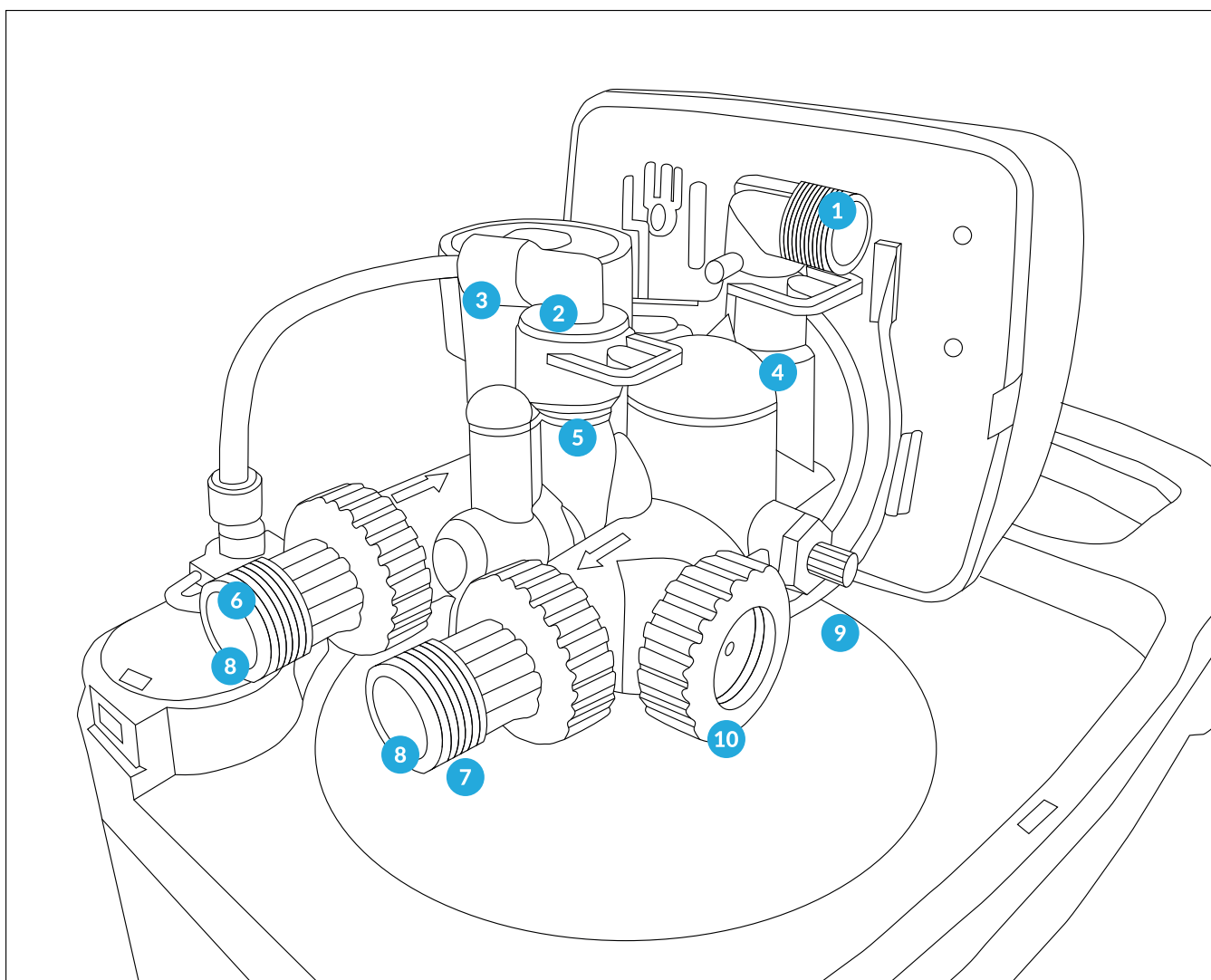

- 1. Drain to the sewage system
- 2. Injector
- 3. Brine hose inlet

- 4. DLFC
- 5. BLFC
- 6. Water inlet

- 7. Water outlet
- 8. 1" connection
- 9. Mixer
- 10. Flow meter

A control valve is an integral part of the device mounted on the pressure cylinder inside the cabinet. It is responsible for the proper functioning of the device, monitors its operation and controls the regeneration process.

Inlet and outlet from the control valve: control valve connection ends are made of plastic - 1" external thread. Thanks to their design, connections can be easily detached from the control valve and do not require additional screws.

Outlet to the sewage system: the outlet to the sewage system on the control valve is made of plastic - 3/4" internal thread. The outlet to the sewage system should preferably be made of plastic (tubes: 25 mm or 32 mm) or alternatively connected to a 3/4 or 1" garden hose adapter and led through the garden hose to the sewage system.

The inlet to the sewage system should be placed within a few metres away or 1 metre above the control valve. Intensity of water discharge into the sewage system while rinsing is close to the nominal capacity of the device.

4.4. INSTALLATION

- Prepare the site for device installation (in accordance with point **4.1. Requirements**).
- Shut off water supply to the installation.
- Make water by-pass according to the diagram.
- Install pre-filter with a filtering cartridge.
- Connect the water inlet to the device.
- Connect the water outlet to the device.
- Connect the sewage system outlet to the drain.
- Connect the overflow elbow located on the brine tank to the sewage system.
- Connect the brine hose to the control valve.
- Start the first regeneration by pressing REGEN for 5 seconds.
- Open the water inlet valve gently to avoid water hammer.
- Supervise subsequent stages of regeneration and check tightness of the system.
- When regeneration finishes, check whether there is water in the brine tank.
- There should be water in the brine tank at the end of regeneration.
- Add a bag of salt tablets into the brine tank.
- Enter the initial hardness and the current time (point 5.2).
- The device is pre-programmed and ready for operation.

The device is ready for operation. All you need to do is enter the hardness and the current time. If you would like to set an operating program for the device, proceed as described in point 5.2.

5. PROGRAMMING

5.1. OPERATING MODE DISPLAYS

- Current time
- Remaining ion-exchange capacity
- Instantaneous flow rate

Press NEXT to move to the next display.

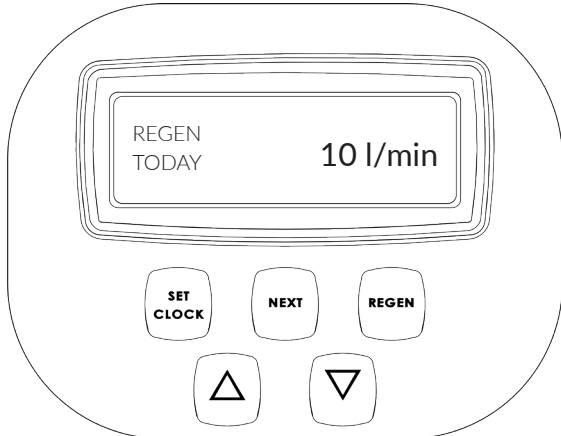
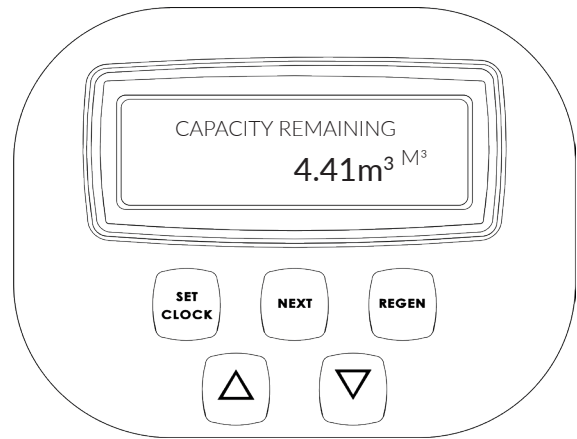
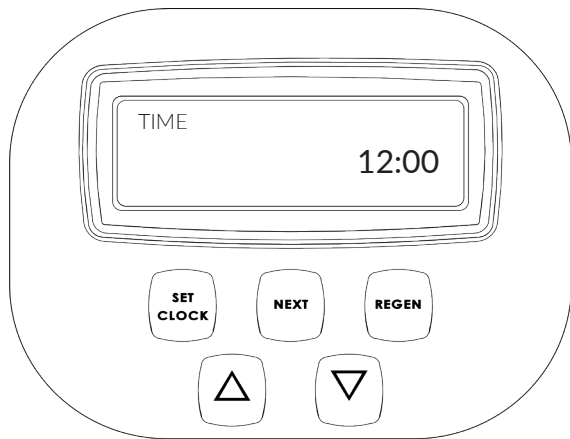

5.2. LANGUAGE

The menu is displayed in English.

5.3. INITIAL SETTINGS

Press NEXT and “up” to enter the basic menu.

5.3.1. Initial hardness

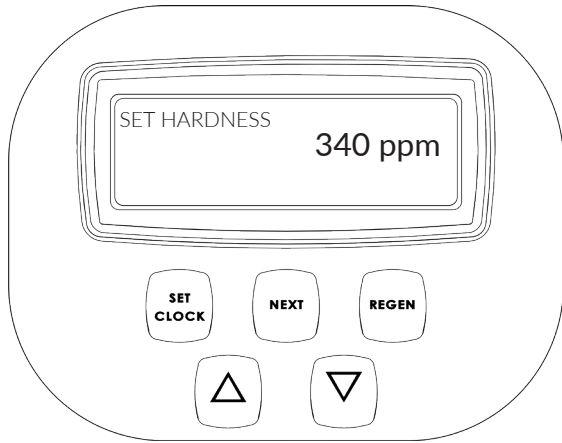

Press “up” and “down” to enter the initial hardness value.

Press NEXT to move on to the next step.

You can return to the previous step by pressing REGEN.

*** Initial hardness is hardness of untreated water (before softening). In Ecoperla Vita, water hardness units are entered in ppm. A table with water hardness unit conversions can be found in point 2.1.**

5.3.2. Final hardness

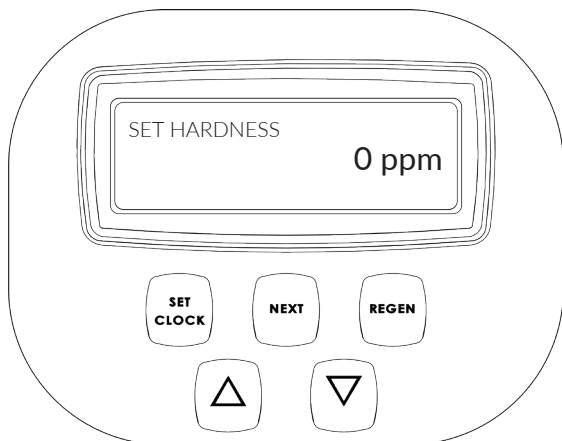

Press “up” and “down” to enter the final hardness value.

Press NEXT to move to the next step.

You can return to the previous step by pressing REGEN.

*** Final hardness is hardness of water flowing out of the device. Entering final hardness does not mean its actual change. It refers to the change of the ion exchange capacity when mixing water.**

In order to set final water hardness, change the settings of the mixer in the control valve.

If the mixer is fully screwed in, enter 0 ppm hardness

In order to accurately verify hardness after changing the mixer settings, check hardness of the inlet water with a hardness drop tester and enter the setting in ppm.

In Ecoperla Vita, water hardness units are entered in ppm. If water hardness is measured in other units, they must be converted to ppm. A conversion table for water hardness units can be found in point 2.1 on page 6.

5.3.3. Days between regenerations

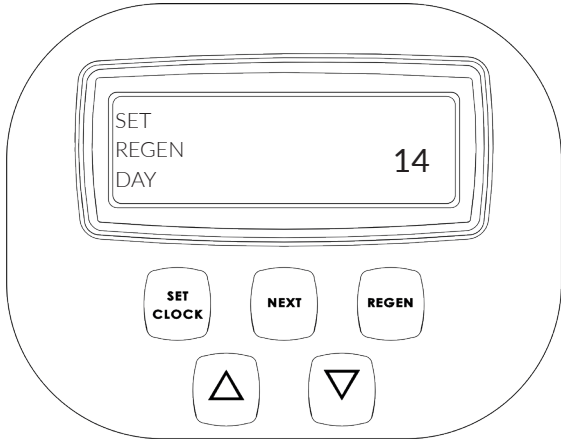

Press “up” and “down” to enter the number of days between regenerations.

For Eco-perla Vita, we recommend setting 14 days.

Press NEXT to move on to the next step.

You can return to the previous step by pressing REGEN.

5.3.4. Regeneration time settings

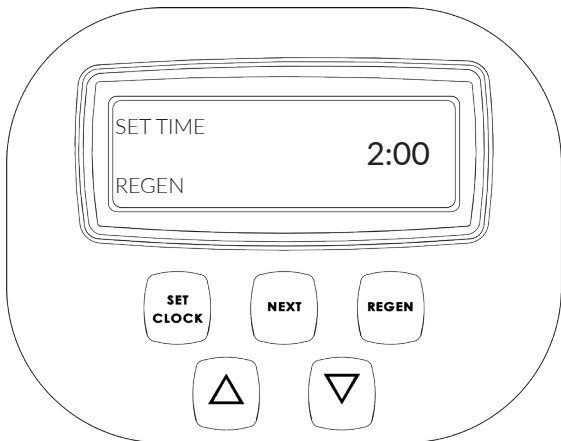

Press “up” and “down” to enter the time when regeneration starts.

In the case of Eco-perla Vita, we recommend setting the regeneration time to 2 a.m., as the water demand is lowest at this time.

Press NEXT twice to move to the end of the control valve setting.

You can return to the previous step by pressing REGEN.

5.3.5. Current time setting

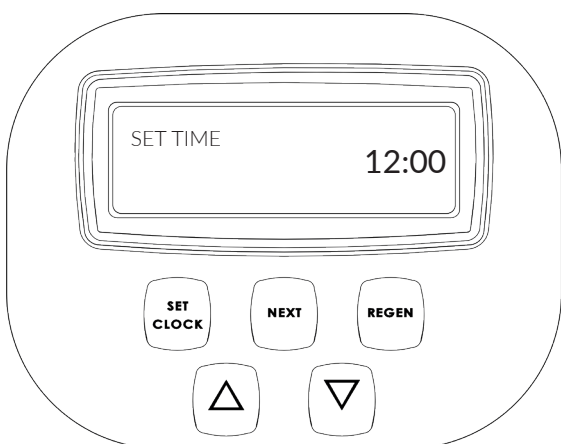

The current time is set in the operating mode displays (point 5.1).

Press SET CLOCK to change.

Press “up” and “down” to set the current time.

After entering the appropriate time, press SET CLOCK or NEXT to confirm the change.

This is the final stage of introducing basic control valve settings.

5.4. INDIVIDUAL OPERATION MODE SETTING

The control valve is programmed in accordance with the purpose of the device. We do not recommend changing the settings without prior consultation with the technical department of the dealer or manufacturer, as this may result in incorrect operation of the device.

Press “down” and NEXT simultaneously (hold until the message on the display changes) to enter the operation mode settings.

5.4.1. Selection of operation mode

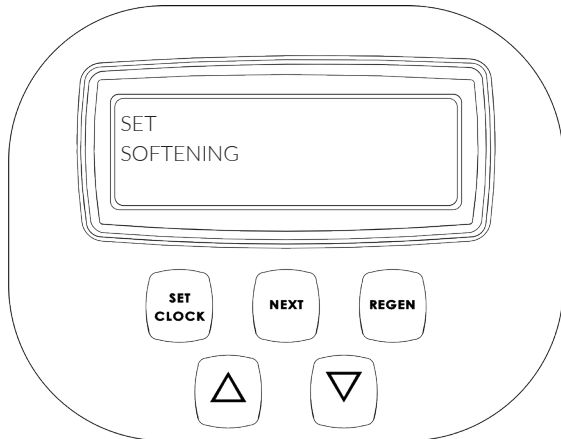

Press “up” and “down” to select the operation mode: softening and filtration.

For Eco-perla Vita, select softening.

Press NEXT to move to the next stage.

You can return to the previous step by pressing REGEN.

5.4.2. Brine-up time

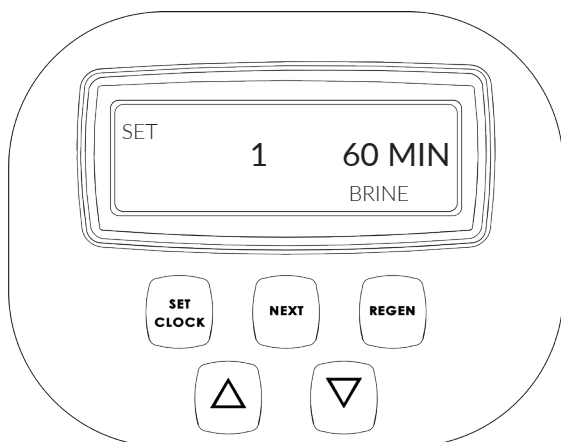

Press “up” and “down” to enter the time in minutes.

Press NEXT to move to the next stage.

You can return to the previous step by pressing REGEN.

5.4.3. Backwash time



Press “up” and “down” to enter the time in minutes.

Press NEXT to move to the next stage.

You can return to the previous step by pressing REGEN.

5.4.4. Rinse time

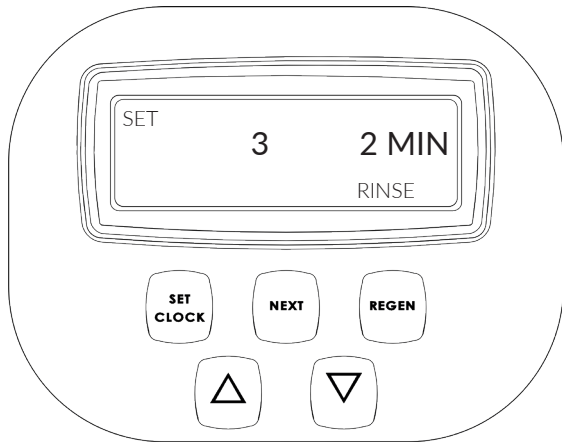

Press “up” and “down” to enter the quick rinse time in minutes.

Press NEXT to move to the next stage.

You can return to the previous step, pressing REGEN

5.4.5. Salt fill in kilograms

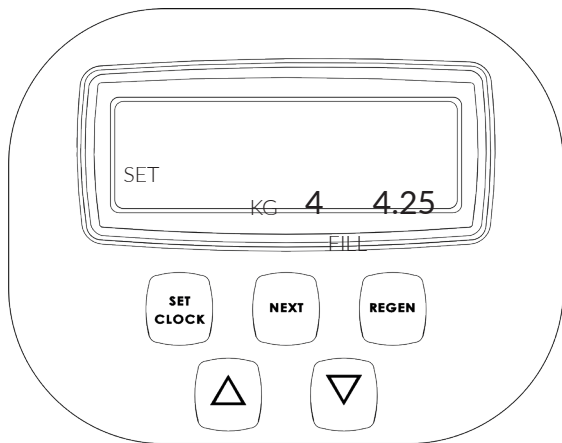

Press “up” and “down” to enter the amount of salt in kilograms.

Press NEXT to move to the next stage.

You can return to the previous step by pressing REGEN.

5.4.6. Ion exchange capacity

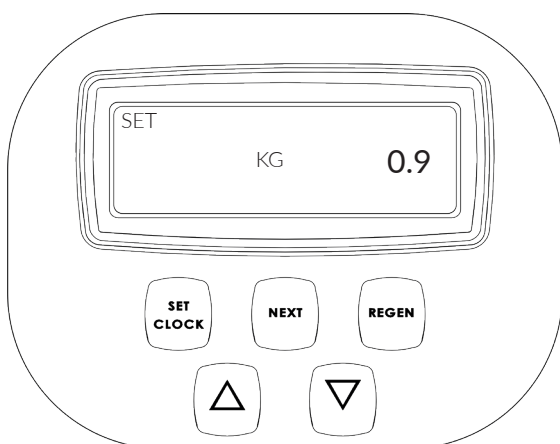

Press “up” and “down” to enter the device ion exchange capacity in kilograms.

Press NEXT to move to the next stage.

You can return to the previous step by pressing REGEN.

5.4.7. Regeneration frequency

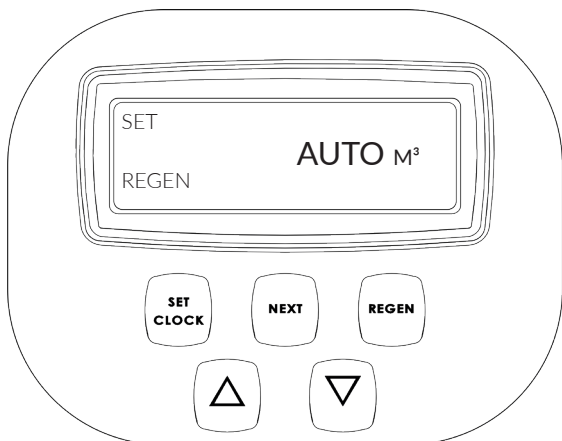

Press “up” and “down” to select the regeneration frequency. It can be set automatically by selecting AUTO.

If you want to enter the frequency yourself, set the regeneration volume (omit the OFF position).

The regeneration frequency can be set between 0.02 and 5,700 m3.

By selecting OFF, you disable volumetric regeneration.

Press NEXT to move to the next stage.

You can return to the previous step by pressing REGEN.

5.4.8. Regeneration type selection

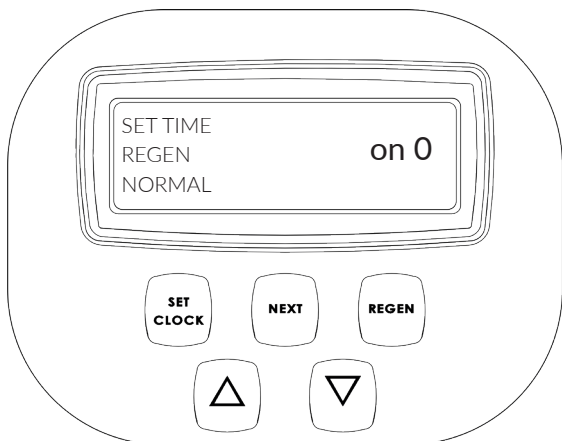

Press “up” and “down” to select one of three regeneration types:

DELAYED: regeneration starts at the set time (P.5.2.5), taking into account the reserve capacity.

IMMEDIATE: regeneration starts as soon as the ion exchange capacity is exhausted.

MIXED: regeneration is delayed or starts as soon as the ion exchange capacity is exhausted.

For Ecoperla Vita, we recommend the DELAYED regeneration setting.

Press NEXT to move to the next stage.

You can return to the previous step by pressing REGEN.

5.4.9. 1st relay settings

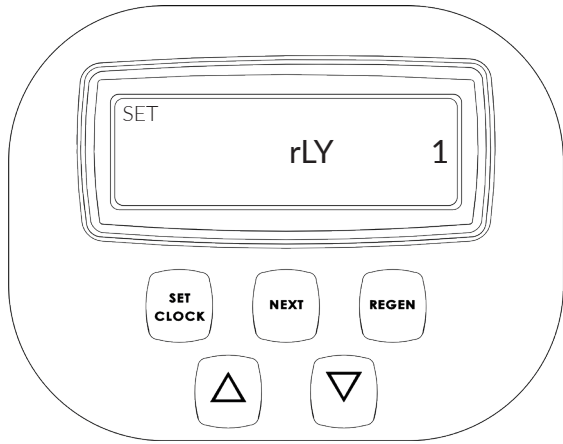

This option pulls the 12 V DC signal from the control valve.

After activating the 1st relay signal, you can choose the way of activating the relay:

- OFF,
- when specified amount of time elapses since the last regeneration, for a specific time (HOUR),
- when specified volume of water flows since the last regeneration, for a specific time or until water flow ceases, depending on which condition is met first (VOLUME),
- each time after specified volume of water has flown through (irrespective of regeneration), for a specific time or until water flow ceases, depending on which condition is met first (REGENERATION VOLUME).

In the next two steps, you set the condition activating the signal (time since regeneration, volume since regeneration or volume) and the duration (minutes and seconds).

Press NEXT to move on to the next step.

5.4.10. 2nd relay settings

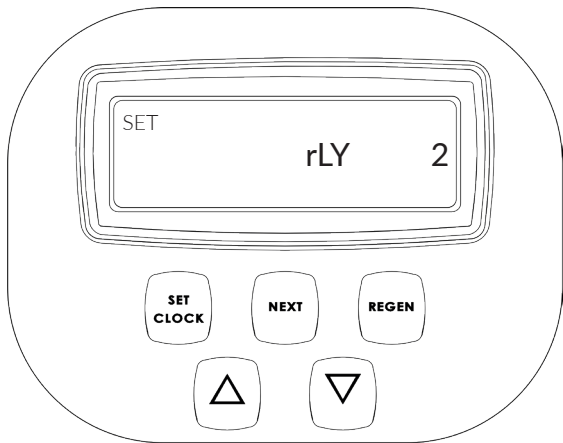

This option pulls the 12 V DC signal from the control valve.

Similarly as for 1st relay signal, but there is an additional function to choose - **signal activation when the valve enters the state of alarm - it turns off when the control valve alarm (ERROR) turns off.**

5.4.11. Remaining salt alert

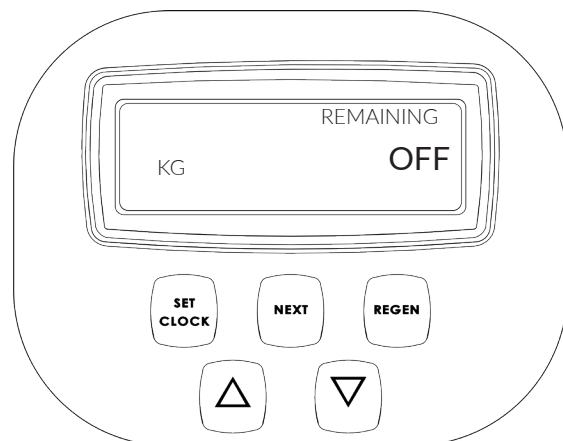

Press "up" and "down" to enter the salt level alarm value from 5 to 200 kg. The OFF option turns off the alarm.

Press NEXT to finish programming.

5.5. OPERATING HISTORY

Press “up” and “down” simultaneously and hold the buttons for 5 seconds until the message on the display changes. You will gain access to the basic operating history of the device.

Press NEXT to move to the next stage. You can return to the previous step by pressing REGEN.

To access the extended history, press “up” and “down” simultaneously and hold the buttons until the message on the display changes.

5.5.1. Number of days since regeneration

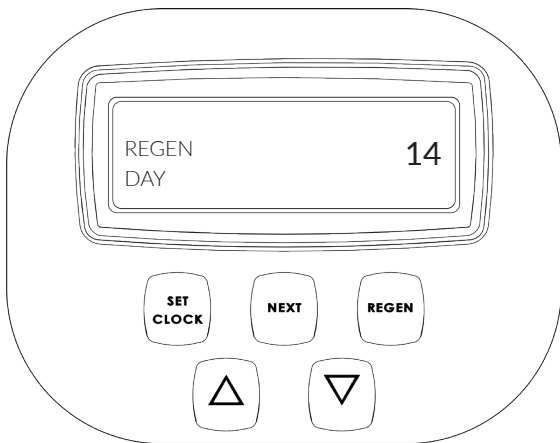

The screen displays the number of days since the last regeneration.

Press NEXT to move to the next stage.

You can return to the previous step by pressing REGEN.

5.5.2. Number of m³ since regeneration

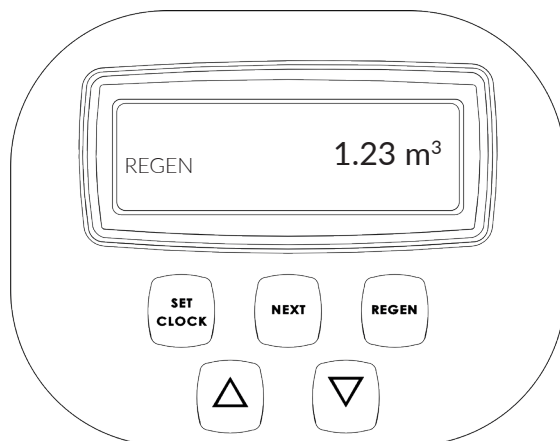

The screen displays the volume of water softened by the appliance since the last regeneration.

Press NEXT to move to the next stage.

You can return to the previous step by pressing REGEN.

5.5.3. Reserve volume

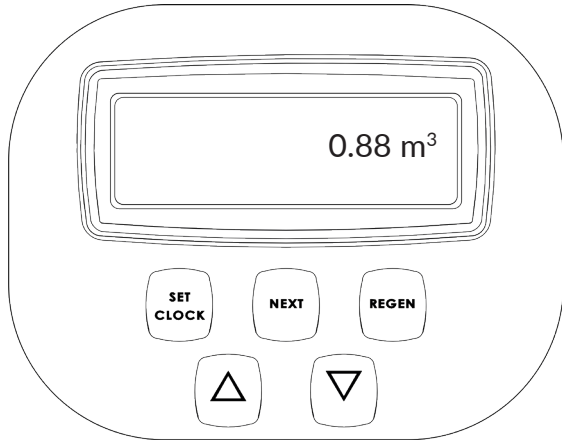

The screen displays reserve volume for 7 days (press “up” and “down” to select the day).

Press NEXT to move to the next stage.

You can return to the previous step by pressing REGEN.

5.5.4. Regeneration history

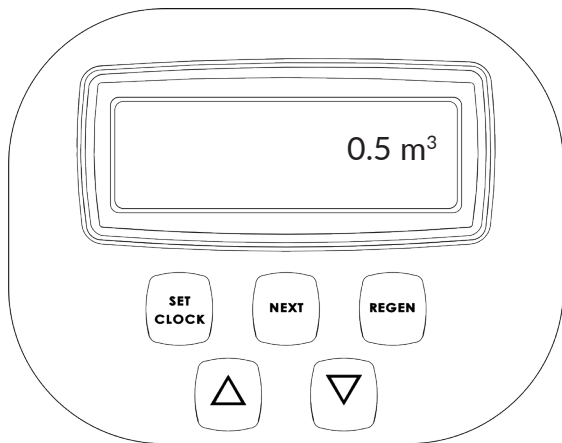

The screen displays the volume of water softened by the device for the last 63 days (press “up” and “down” to select a day).

Press NEXT to move to the next stage.

You can return to the previous step by pressing REGEN.

5.5.5. Maximum instantaneous flow

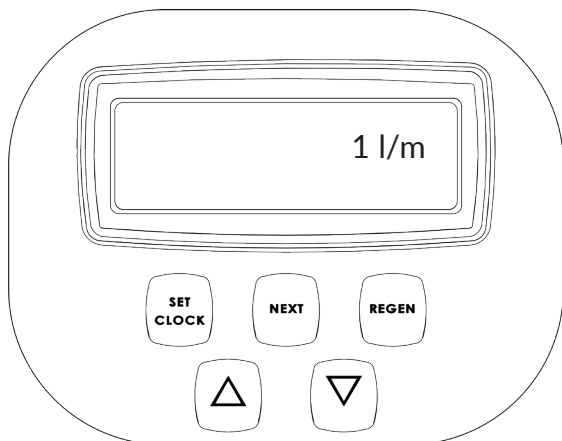

The screen displays the maximum instantaneous water flow readings for the last 7 days. Press “up” and “down” to select the day.

Press NEXT to move to the next stage.

You can return to the previous step by pressing REGEN.

5.6. EXTENDED HISTORY

5.6.1. Software version

The screen displays a current software version. Press NEXT to move to the next stage.

You can return to the previous step by pressing REGEN.

5.6.2. Total number of days

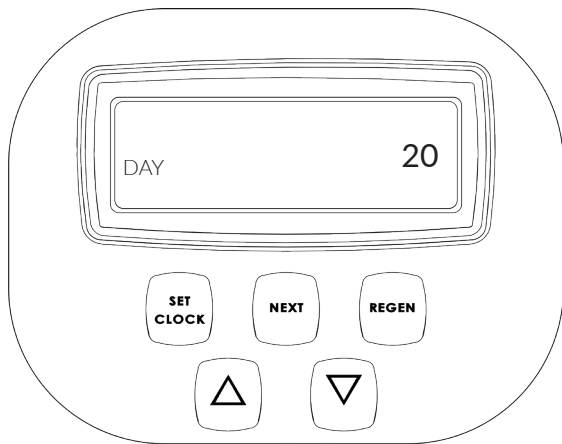

The screen displays the total number of days of device operation.

Press NEXT to move to the next stage.

You can return to the previous step by pressing REGEN.

5.6.3. Total number of regenerations

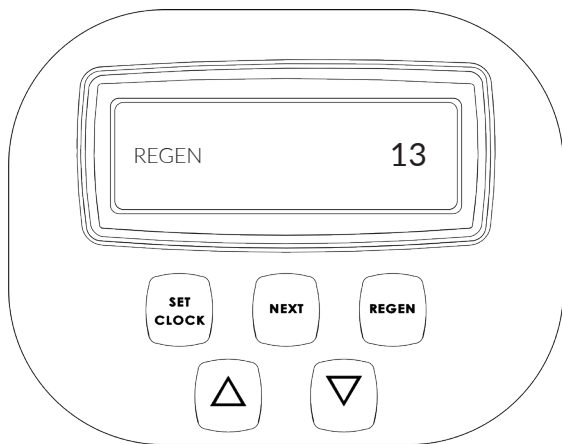

The screen displays the total number of device regenerations.

Press NEXT to move to the next stage.

You can return to the previous step by pressing REGEN.

5.6.4. Total volume

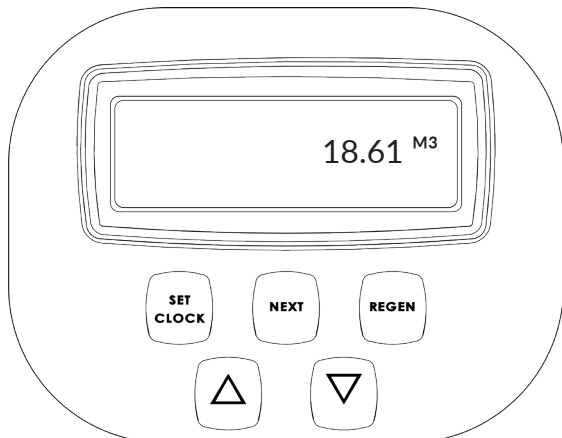

The screen displays the total volume of water treated by the device.

Press NEXT to move to the next stage.

You can return to the previous step by pressing REGEN.

5.6.5. Error history

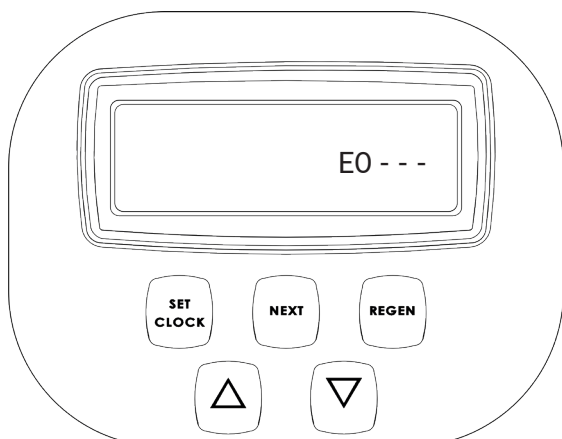

The screen displays the last 10 control valve errors (press "up" and "down" to display further errors).

Press NEXT to exit the extended history.

You can return to the previous step by pressing REGEN.

6. OPERATION

6.1. WATER SOFTENER OPERATION

The water softening system requires adding salt tablets to the brine tank. Salt demand depends on total hardness of raw water and average water consumption.

The system requires regular, periodic regeneration. Regeneration takes place automatically. This process requires appropriate volume of water and salt for rinsing and brining the medium. These values will vary, depending on the size of the device.

BEWARE: Any modifications made by the User or Installer not authorised by the manufacturer will void the warranty and often cause malfunctions of the device.

6.2. GENERAL INFORMATION

To ensure long-term and trouble-free operation of the water softener, maintenance services must be performed at regular intervals and a record of the activities performed must be kept.

If you sign a service agreement with the supplier, the supplier will assume responsibility for performing regular maintenance on the system.

6.3. LIST OF REQUIREMENTS FOR PROPER OPERATION

- Correct connection of the device according to the user manual,
- Using a pre-filter,
- Raw water quality in compliance with drinking water standards, in particular with respect to iron and manganese content, turbidity, pH, chloride and microbial content,
- Suitable working conditions: temperature within the required limits, low humidity in the room, protection against atmospheric factors (sunshine, precipitation, etc.),
- Making sure that the pressure in the device does not rise above the maximum operating pressure and below the atmospheric pressure of 0 bar (vacuum),
- Electrical supply with the correct voltage and frequency in accordance with national standards,
- Ensuring adequate patency and throughput of wash water reject into the sewage system,
- Commissioning of the device in accordance with the user manual,
- Entering the value of the raw water hardness into the device controller,
- Correct operation in accordance with the user manual,
- Closing the emergency bypass of the device,
- Regular replenishment of salt and replacement of cartridges in the mechanical filter.

6.4. CZYNOŚCI EKSPLOATACYJNE UŻYTKOWNIKA

The user is required to carry out the following maintenance procedures:

- Regular replacement of the pre-filter cartridge (depending on the contamination degree, but at least every 6 months),
- Replenishment of salt tablets in the salt container,
- Monitoring of irregularities in device operation (e.g. alarm displayed on the controller, large amount of water in the salt container, no salt consumption, leaks, poor quality of treated water).

6.5. MEDIUM CLEANING

We recommend using Ecoperla Antidotum granules for device maintenance. Use the product only for its intended purpose.

6.6. MEDIUM DISINFECTION

We recommend using Ecoperla Antibacter for disinfecting and maintaining the filtering medium. Use the product only for its intended purpose.

6.7. CONSUMABLES

- Salt tablets (usually packed in 25 kg bags) – amount depending on water hardness and water consumption.
- Pre-filter cartridges in the required mechanical filter – usually replaced every 2-6 months.
- Ecoperla Antidotum, recommended for removing deposits from the medium – once a year according to the user manual.
- Ecoperla Antibacter, recommended for disinfection and maintenance – once a year according to the user manual.
- Medium – replaced every 5-10 years depending on water quality.
- Injector – replaced every 2-5 years, may need to be replaced if hardness is very high or water quality is low.
- Piston guide and piston – replaced every 2-5 years, may need to be replaced if hardness is very high or water quality is low.

6.8. LOSS OF WARRANTY

The device must be installed and operated in accordance with its intended use and user manual and in appropriate conditions.

Some negligence or irregularities in this respect may result in loss of warranty.

Factors that may void the warranty include:

- Poor quality of raw water (in particular if drinking water exceed quality standards in terms of iron and manganese content, turbidity, pH, chlorides and microorganisms),
- No pre-filter, no cartridge in pre-filter,
- Wrong hydraulic connection (e.g. interchange of inlet and outlet),
- No or insufficient drainage of wash water into the sewage system,
- No venting at commissioning or significant amount of air in the device,
- Poor quality salt tablets (contaminated / loose / without certificate of the National Institute of Hygiene),
- Pressure in the system below 0 bar (vacuum) or above 6 bar,
- Water hammer in the system,
- Temperature too low (below 4°C) or too high (above 45°C),
- Change of controller settings or disassembling the device, or its modification without consulting the manufacturer's technical department,
- Use of chemical agents which have a negative impact on the medium or the device,
- Failure to add salt, to regenerate the device,
- Vandalism or other mechanical damages.

In the case of any of the above-mentioned irregularities, the warranty will be voided; the decision of warranty loss is taken by the warranter. As the above mentioned inappropriate connection or operation does not always cause damage, the warranter may decide to maintain the warranty of the device.

7. SERVICE

7.1. ACTIVITIES PERFORMED BY SERVICE TECHNICIAN

To ensure many years of trouble-free operation and a 10-year warranty period, the device should be serviced annually after the second year of operation.

Basic service activities performed by the service technician during the inspection:

- Checking water hardness,
- Checking brine intake,
- Checking/cleaning/replacing the injector,
- Checking operation of flow meter,
- Checking the salt level in the brine tank,
- Checking the pre-filter cartridge,
- Checking operation of the device,
- Checking for leaks,
- Issuing of a protocol.

Additional activities performed by service technician (may be additionally charged):

- Replacement of the pre-filter cartridge,
- Salt refilling,
- Providing consumables,
- Checking/change of controller settings,
- Mixer adjustment,
- Control valve (piston, guide, etc.) cleaning.

7.2. GROUNDLESS REQUEST FOR WARRANTY SERVICE

If the device does not work properly, you should check if it is not caused by incorrect operation before calling a service technician. In case of groundless request for warranty service, you will be charged with costs of travel and service.

Groundless request refers to the following cases:

- All cases listed under “**Loss of warranty**”,
- No salt in the salt container,
- Unscrewed bypass valve (raw water bypasses the device),
- Wrongly entered water hardness value,
- Too low feed water pressure,
- A significant change in the quality of the feed water, which has a negative impact on the device operation,
- Failure to replace consumables in accordance with the user manual.

8. TROUBLESHOOTING

Problem	Possible cause	Solution
1. Control board not displayed on the screen.	a. No power at the electrical outlet.	a. Repair the damaged outlet or use another working outlet.
	b. Power supply unit is not connected to the outlet or to the control board.	b. Connect the power supply unit into the outlet or control board.
	c. Wrong power supply voltage.	c. Connect to power supply with correct voltage.
	d. Damaged power supply unit.	d. Replace the power supply unit.
	e. Defective control board.	e. Replace the control board.
2. Time displayed on the control board screen is incorrect.	a. The power supply unit is connected to the outlet controlled by a switch.	a. Connect the power supply unit to the outlet with constant power.
	b. The breaker and/or fuse is turned off.	b. Turn on the fuse and/or breaker.
	c. Power failure.	c. Reset time. There is a backup battery on the control board that may be dead. Replace the battery as well.
	d. Defective control board.	d. Replace the control board.
3. The display does not indicate water flow. Refer to the user manual to find out how the display indicates water flow.	a. Open by-pass valve.	a. Close the by-pass valve.
	b. The flow meter is not connected to the control board.	b. Connect the flow meter connector to the METER control board.
	c. Blocked or dirty flow meter turbine.	c. Remove the flow meter. Make sure that it rotates and that there is no dirt inside.
	d. The water meter is not connected to control board.	d. Connect the water meter to the METER connector on the control board.
	e. Defective water meter.	e. Replace the flow meter.
	f. Defective control board.	f. Replace the control board.
4. Regeneration at wrong time of day.	a. Power failure.	a. Set the correct time. If there is an emergency power supply battery in the control valve, it must be replaced.
	Refer to the user manual for a drawing of the front cover and drive assembly for battery location.	b. Ustaw prawidłową godzinę.
	b. Incorrectly set time.	b. Set the correct time.
	c. Incorrectly set regeneration time.	c. Set the regeneration time.
	d. The controller is set to the immediate regeneration mode.	d. Check the regeneration type programming procedure and set the
5. The current time is flashing.	a. Power failure.	a. Set the correct time. If the control board has a battery backup, the battery may be exhausted.
6. Regeneration does not start when the appropriate buttons are pressed.	a. Damaged drive gears.	a. Replace the gears.
	b. Damaged main piston or regeneration piston.	b. Replace main piston or regeneration piston.
	c. Defective control board.	c. Replace the control board.
7. Regeneration does not start automatically, but starts when initiated with the appropriate buttons.	a. Shut-off valve/bypass is open.	a. Close the shut-off valve/bypass.
	b. The water meter is connected to the wrong connector on the control board.	b. Connect the water meter to the METER connector on the control board.
	c. Blocked/stopped water meter turbine.	c. Disconnect the water meter and make sure that the turbine is not blocked.

Problem	Possible cause	Solution
	d. Wrong programming.	d. Refer to the programming instructions.
	e. The water meter is not connected to control board.	e. Connect the water meter to the METER connector on the control board.
	f. Defective water meter.	f. Replace the water meter.
	g. Defective control board.	g. Replace the control board.
8. Hard or untreated water at the control valve outlet.	a. The by-pass valve is open or faulty.	a. Close the by-pass valve completely or replace it.
	b. The medium is exhausted due to high water intake.	b. Check programming or diagnostics for abnormal water consumption.
	c. The water meter does not calculate flow.	c. Disconnect the water meter and make sure that the turbine is not blocked by foreign material.
	d. Fluctuating water parameters.	d. Perform water analysis and adjust programming settings.
	e. No or insufficient regenerant in the tank.	e. Add regenerant to the tank.
	f. The control valve does not suck in regenerant.	f. Refer to point 12.
	g. Too little regenerant solution in tank.	g. Check regenerant tank fill settings in programming, check BLFC to find and remove blockage
	h. Defective piston gaskets/guide.	h. Check and replace the gaskets
	i. Control valve and piston are not compatible.	i. Select compatible correct control valve and piston
	j. Contaminated medium.	j. Replace the medium
9. Control valve uses too much regenerant.	a. Wrong fill settings.	a. Check fill settings.
	b. Wrong programming.	b. Check programming and make sure it is appropriate for water parameters and process needs.
	c. Too frequent regenerations.	c. Check for leaks that may exhaust the ion exchange capacity and make sure that the system is not too small.
10. Regenerant leaks into treated water.	a. Feed water pressure too low.	a. Check feed water pressure (minimum 1.7 bar).
	b. Incorrect injector size.	b. Replace the injector.
	c. Blocked DLFC line.	c. Check and clean the DLFC line.
11. Too much water in regenerant tank.	a. Wrong programming.	a. Check filling cycle settings.
	b. Blocked injector.	b. Remove the injector, clean or replace it.
	c. The gears are not tightened.	c. Tighten the gears.
	d. Defective piston gaskets/guide.	d. Replace gaskets/piston guide.
	e. Bent or blocked drain line.	e. Check the drain line for bends or debris. Unblock or bend the sewer drain line.
	f. Clogged DLFC restrictor.	f. Clean or replace the DLFC restrictor.
	g. No BLFC restrictor.	g. Replace the BLFC restrictor.
12. The control valve does not suck in regenerant.	a. Blocked injector.	a. Clean or replace the injector.
	b. Damaged regeneration piston.	b. Replace regeneration piston.
	c. Leaking regenerant line.	c. Check regenerant line for air leakage.

Problem	Possible cause	Solution
13. Treated water leaks into the drain.	a. Power failure during regeneration.	a. Regeneration will be completed when power is restored, set correct time, check battery status.
	b. Damaged gaskets/piston guide.	b. Replace the gasket/piston guide.
	c. Damaged piston.	c. Replace the piston.
	d. The gears are not tightened.	d. Tighten the gears.
14. E1/1001 defect (the display shows the code or code alternately with: Error or Err). The control valve did not detect motor movement.	a. Incorrectly or incompletely installed motor, damaged or disconnected power wires.	a. Disconnect power supply. Make sure that the motor is fully switched off. Check for broken wires and make sure the two-pin connector on the motor is connected to the two-pin connector on the PC board marked MOTOR. Press NEXT and REGEN for 3 seconds to re-synchronize the software to the piston position or disconnect power from the PC board for 5 seconds. Disconnect power from the PC board for 5 seconds, then reconnect.
	b. The control board is incorrectly installed.	b. Snap the PC board into the drive bracket correctly, then press NEXT and REGEN for 3 seconds to synchronize the software with the piston position or disconnect power from the PC Board for 5 seconds, then reconnect.
	c. The drive gears are damaged or incorrectly installed.	c. Replace the damaged gears.
15. E2/1002 defect (the display shows the code or code alternately with: Error or Err). The control valve motor ran too short and did not stop in position for the next regeneration cycle.	a. Mechanical blocking inside the control valve.	a. Open the control valve and check condition of the piston and gaskets. *Reset the PC board.
	b. Mechanical blocking outside the control valve.	b. Check the piston and gaskets/piston guide. Check the gears, mounting and gearbox. Reset the PC board*.
	c. The drive gears are too tightly screwed to the housing.	c. Loosen the gears. Reset the PC board*.
	d. Wrong control board power supply voltage.	d. Connect to the power supply with the correct voltage and reset the PC board*.
16. E3/1003 defect (the display shows the code or code alternately with: Error or Err). The control valve motor ran too long and was not in position for the next regeneration cycle.	a. Damage to the motor during regeneration.	a. Check connection or replace the motor and reset control board*.
	b. Dirt on piston and/or control valve gaskets causing high motor resistance.	b. Replace or clean piston and control valve gaskets and reset the control board*.
	c. The motor and PC board bracket is not tightened to housing. The motor does not mesh with drive gear.	c. Correct installation of the motor bracket and reset the control board*.
17. E4/1004 defect (the display shows the code or code alternately with: Error or Err). The control valve motor ran too long and did not stop in the OPERATION position.	a. The motor and PC board bracket is not tightened to the rest of the housing; the motor does not mesh with drive gear.	a. Correct installation of the motor bracket and reset the control board*.
18. 1006 defect (the display shows code alternating with: Error). The MAV/SEPS/NHBP** valve motor ran too long and did not stop in the correct position.	a. The control valve is programmed as ALT A, ALT B, NGBP or SEPS did not detect a connected MAV or NHBP valve.	a. Reset the control board* and check programming.
	b. Unconnected MAV/NHBP valve supply cable to the control board.	b. Connect the MAV/NHBP valve supply cable to the control board*.
	c. The MAV/NHBP valve motor did not mesh with the drive gear.	c. Correct installation of the MAV/NHBP valve motor and reset the control board.

Problem	Possible cause	Solution
	d. Dirt on MAV/NHBP valve piston and/or gaskets causing high motor resistance.	d. Replace or clean the piston and gaskets of the MAV/NHBP valve and reset the control board.
19. 1007 defect (the display shows code alternating with: Error). The MAV/SEPS/NHBP** valve motor ran too short and did not stop in the correct position.	a. Mechanical blocking inside the MAV/NHBP valve.	a. Open the MAV/NHBP valve and check the piston and piston gaskets/guide for debris. Reset the PC board*.
	b. Mechanical blocking on the outside of the MAV/NHBP valve.	b. Check the piston gaskets/piston guide, mounting, gearbox. Check the MVA/NHBP valve.
20. 4002 defect.	a. Memory error.	a. Replace the control board.

The PC board can be reset by:

- pressing NEXT and REGEN simultaneously and holding them for 3 seconds
- disconnecting the power supply from the PC board and reconnecting it after 5 seconds

** MAV - Motorized Alternating Valve
SEPS - Separate Source Water Regeneration
NHBP - No Hard Water Bypass

9. SERVICE CARD

Maintenance service after 2 years of operation	Date of maintenance service:	Maintenance service after 3 years of operation	Date of maintenance service:
Signature of the service technician:		Signature of the service technician:	
Stamp of the service technician:		Stamp of the service technician:	
Maintenance service after 4 years of operation	Date of maintenance service:	Maintenance service after 5 years of operation	Date of maintenance service:
Signature of the service technician:		Signature of the service technician:	
Stamp of the service technician:		Stamp of the service technician:	
Maintenance service after 6 years of operation	Date of maintenance service:	Maintenance service after 7 years of operation	Date of maintenance service:
Signature of the service technician:		Signature of the service technician:	
Stamp of the service technician:		Stamp of the service technician:	
Maintenance service after 8 years of operation	Date of maintenance service:	Maintenance service after 9 years of operation	Date of maintenance service:
Signature of the service technician:		Signature of the service technician:	
Stamp of the service technician:		Stamp of the service technician:	

10. WARRANTY

The dealer warrants efficiency of the Eco-perla Vita system in accordance with the warranty conditions included in the user manual.

In order to execute the warranty, you need to present proof of purchase of the system. In the case of a problem with the Eco-perla Vita system, please contact your dealer.

SERIAL NUMBER

AUTHORISED DEALER / SERVICE CENTRE



ECOPERLA

